

International  
**IOR** Rectifier

**6CWQ10FN**

SCHOTTKY RECTIFIER

7 Amp

$$I_{F(AV)} = 7\text{Amp}$$

$$V_R = 100\text{V}$$

#### Major Ratings and Characteristics

Characteristics	Values	Units
$I_{F(AV)}$ Rectangular waveform	7	A
$V_{RRM}$	100	V
$I_{FSM}$ @ tp = 5 $\mu$ s sine	440	A
$V_F$ @ 3 Apk, $T_J = 125^\circ\text{C}$ (per leg)	0.63	V
$T_J$ range	-40 to 150	$^\circ\text{C}$

#### Description/ Features

The 6CWQ10FN surface mount, center tap, Schottky rectifier series has been designed for applications requiring low forward drop and small foot prints on PC board. Typical applications are in disk drives, switching power supplies, converters, free-wheeling diodes, battery charging, and reverse battery protection.

- Popular D-PAK outline
- Center tap configuration
- Small foot print, surface mountable
- Low forward voltage drop
- High frequency operation
- Guard ring for enhanced ruggedness and long term reliability

#### Case Styles



D-PAK (TO-252AA)

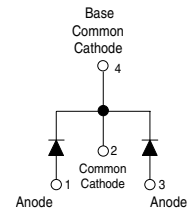

## Voltage Ratings

Part number	6CWQ10FN
$V_R$ Max. DC Reverse Voltage (V)	100
$V_{RWM}$ Max. Working Peak Reverse Voltage (V)	

## Absolute Maximum Ratings

Parameters	6CWQ...	Units	Conditions
$I_{F(AV)}$ Max. Average Forward (Per Leg) Current * See Fig. 5 (Per Device)	3.5	A	50% duty cycle @ $T_C = 135^\circ\text{C}$ , rectangular wave form
	7		
$I_{FSM}$ Max. Peak One Cycle Non-Repetitive Surge Current (Per Leg) * See Fig. 7	440	A	5 $\mu\text{s}$ Sine or 3 $\mu\text{s}$ Rect. pulse 10ms Sine or 6ms Rect. pulse
	70		
$E_{AS}$ Non-Repetit. Avalanche Energy (Per Leg)	5.0	mJ	$T_J = 25^\circ\text{C}$ , $I_{AS} = 1$ Amp, $L = 10$ mH
$I_{AR}$ Repetitive Avalanche Current (Per Leg)	0.5	A	Current decaying linearly to zero in 1 $\mu\text{sec}$ Frequency limited by $T_J$ max. $V_A = 1.5 \times V_R$ typical

## Electrical Specifications

Parameters	6CWQ...	Units	Conditions
$V_{FM}$ Max. Forward Voltage Drop (Per Leg) * See Fig. 1 (1)	0.81	V	@ 3A $T_J = 25^\circ\text{C}$
	0.96	V	@ 6A
	0.63	V	@ 3A $T_J = 125^\circ\text{C}$
	0.74	V	@ 6A
$I_{RM}$ Max. Reverse Leakage Current (Per Leg) * See Fig. 2 (1)	1	mA	$T_J = 25^\circ\text{C}$
	4.9	mA	$T_J = 125^\circ\text{C}$ $V_R = \text{rated } V_R$
$V_{F(TO)}$ Threshold Voltage	0.48	V	$T_J = T_J \text{ max.}$
$r_t$ Forward Slope Resistance	30.89	m $\Omega$	
$C_T$ Typ. Junction Capacitance (Per Leg)	92	pF	$V_R = 5V_{DC}$ (test signal range 100Khz to 1Mhz) $25^\circ\text{C}$
$L_S$ Typical Series Inductance (Per Leg)	5.0	nH	Measured lead to lead 5mm from package body
dv/dt Max. Voltage Rate of Change	10000	V/ $\mu\text{s}$	(Rated $V_R$ )

(1) Pulse Width < 300 $\mu\text{s}$ , Duty Cycle <2%

## Thermal-Mechanical Specifications

Parameters	6CWQ...	Units	Conditions
$T_J$ Max. Junction Temperature Range (*)	-40 to 150	$^\circ\text{C}$	
$T_{stg}$ Max. Storage Temperature Range	-40 to 150	$^\circ\text{C}$	
$R_{thJC}$ Max. Thermal Resistance (Per Leg) Junction to Case (Per Device)	4.70	$^\circ\text{C}/\text{W}$	DC operation * See Fig. 4
	2.35		
wt Approximate Weight	0.3 (0.01)	g (oz.)	
Case Style	D-Pak		Similar to TO-252AA
Marking Device	6CWQ10FN		

(\*)  $\frac{dP_{tot}}{dT_J} < \frac{1}{R_{th(j-a)}}$  thermal runaway condition for a diode on its own heatsink

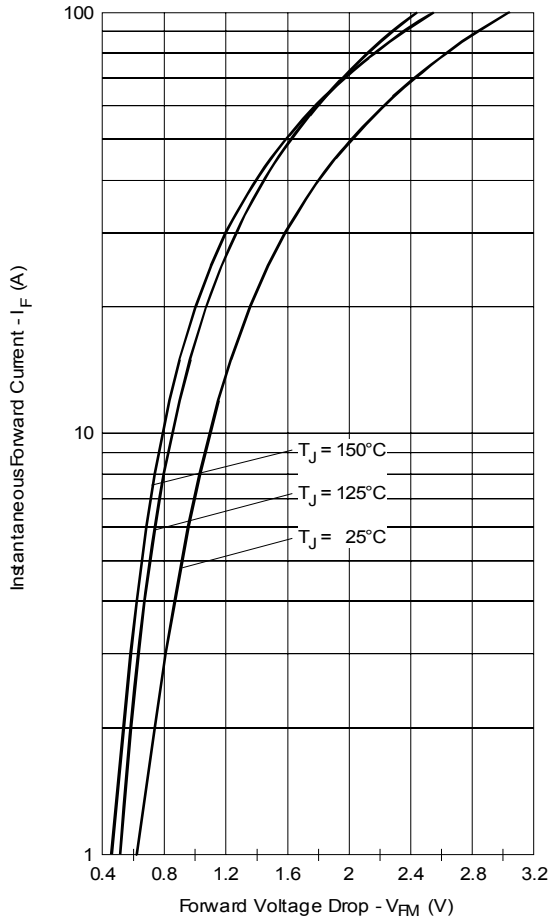

Fig. 1 - Max. Forward Voltage Drop Characteristics (Per Leg)

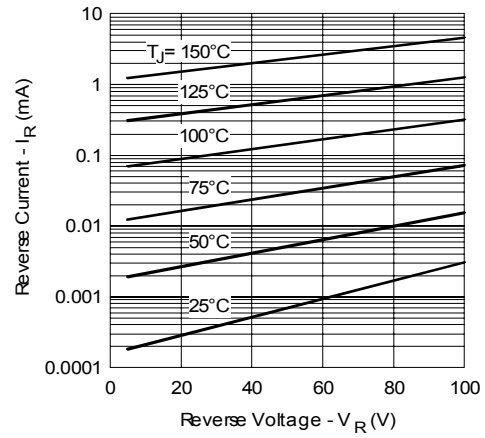

Fig. 2 - Typical Values Of Reverse Current Vs. Reverse Voltage (Per Leg)

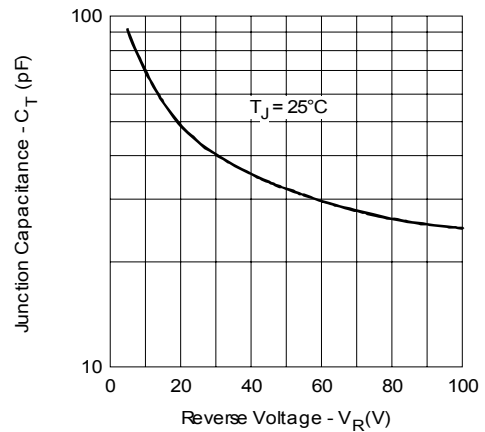

Fig. 3 - Typical Junction Capacitance Vs. Reverse Voltage (Per Leg)

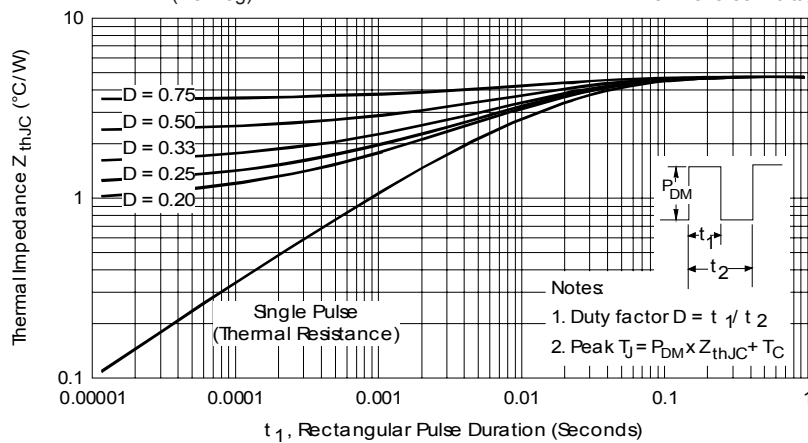

Fig. 4 - Max. Thermal Impedance  $Z_{thJC}$  Characteristics (Per Leg)

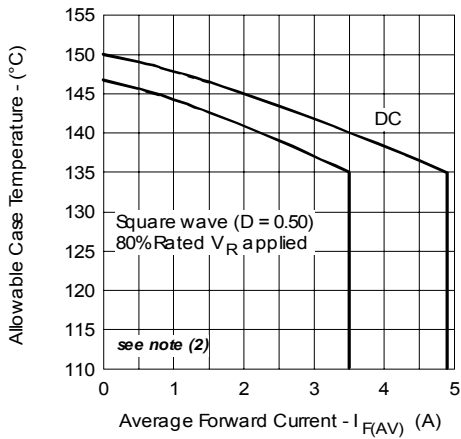

Fig. 5 - Max. Allowable Case Temperature Vs. Average Forward Current (Per Leg)

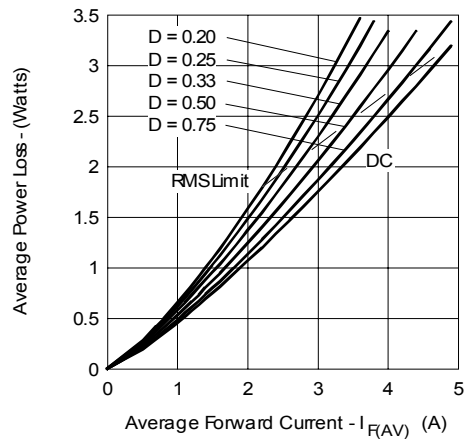

Fig. 6 - Forward Power Loss Characteristics (Per Leg)

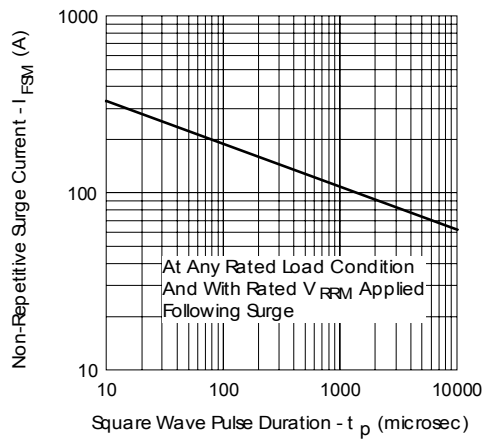
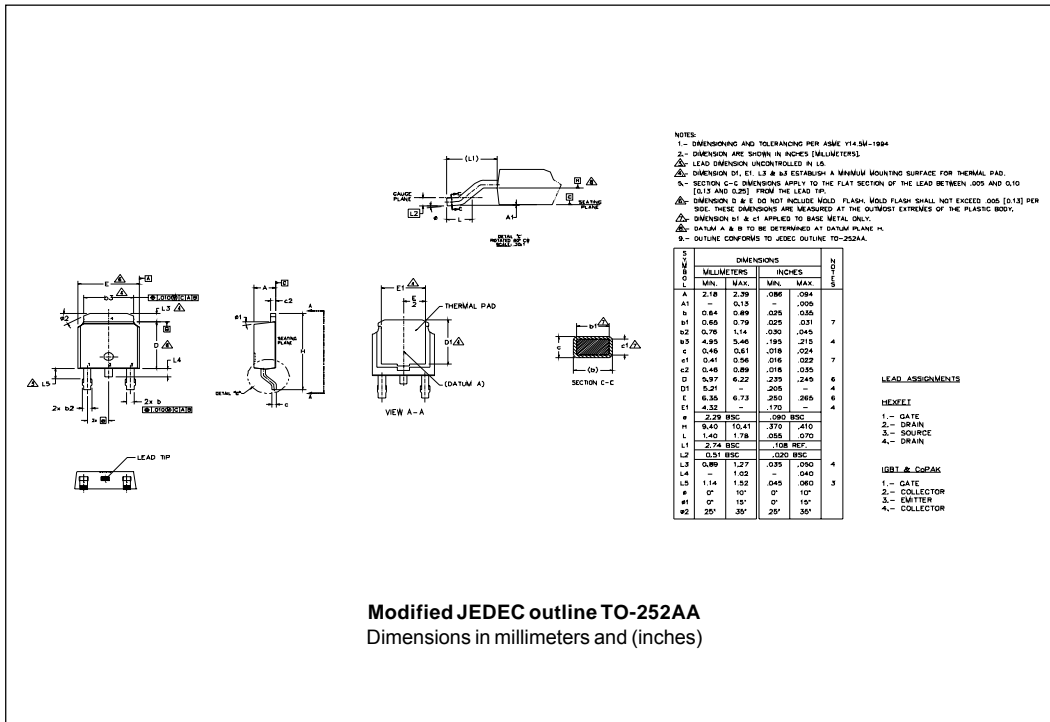

Fig. 7 - Max. Non-Repetitive Surge Current (Per Leg)

(2) Formula used:  $T_C = T_J - (P_d + P_{d_{REV}}) \times R_{thJC}$ ;  
 $P_d = \text{Forward Power Loss} = I_{F(AV)} \times V_{FM} @ (I_{F(AV)} / D)$  (see Fig. 6);  
 $P_{d_{REV}} = \text{Inverse Power Loss} = V_{R1} \times I_{R1} (1 - D); I_{R1} @ V_{R1} = 80\% \text{ rated } V_R$

Outline Table



Part Marking Information

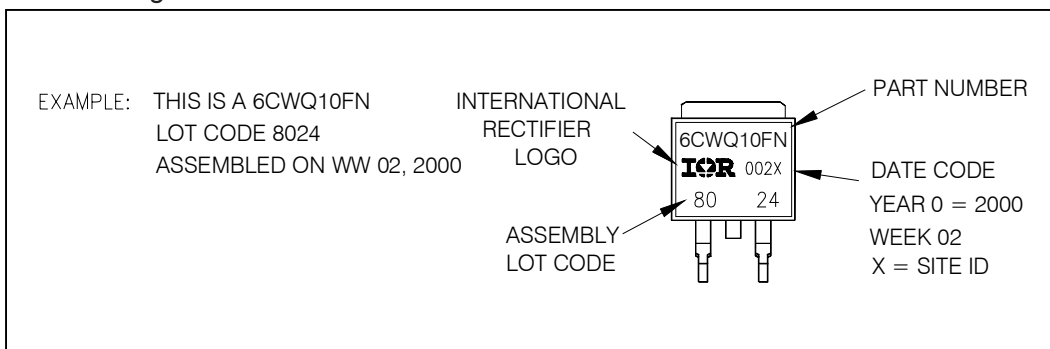

Tape & Reel Information

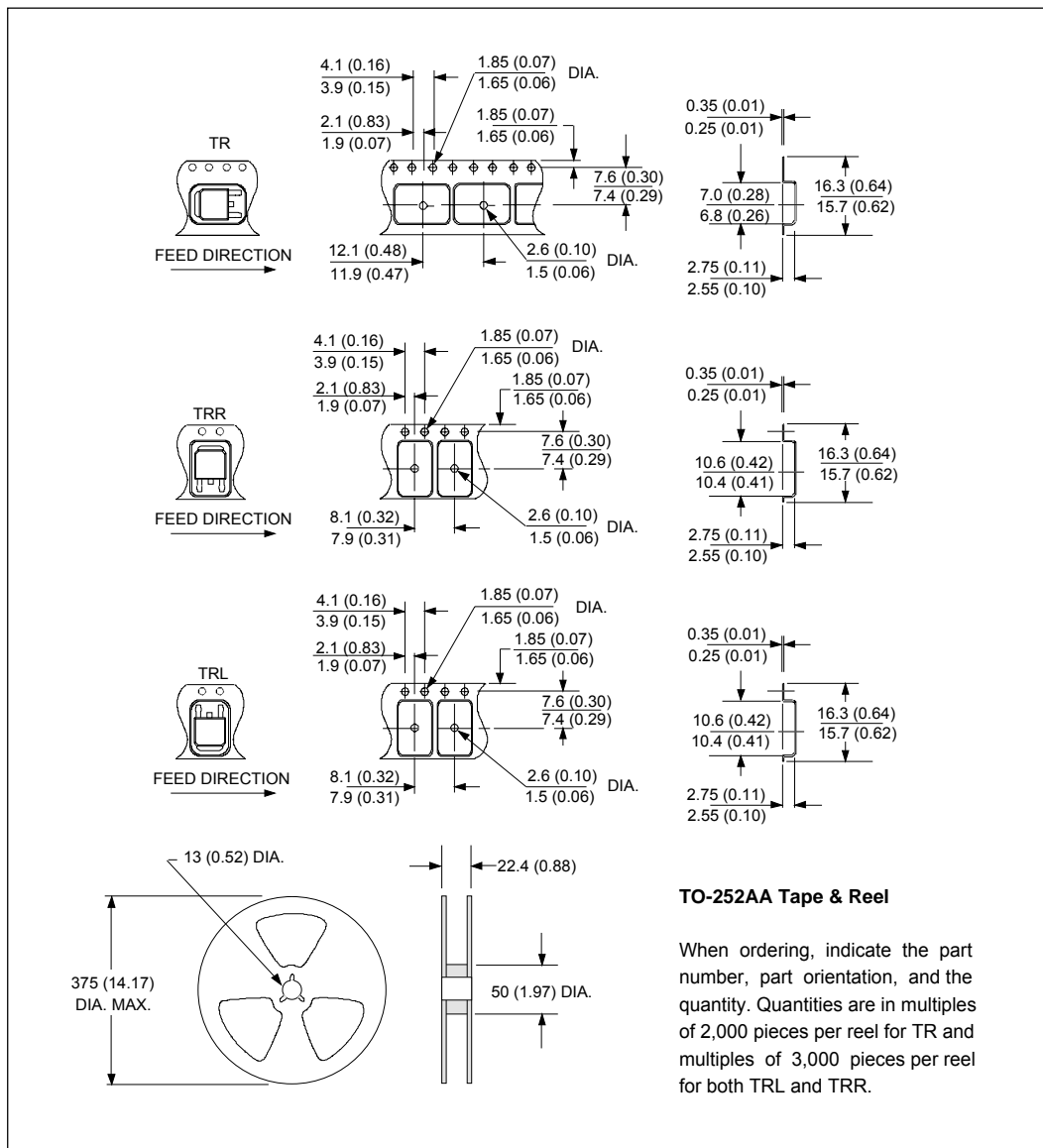

Ordering Information Table

Device Code	
<b>6</b>	<b>C</b>
<b>W</b>	<b>Q</b>
<b>10</b>	<b>FN</b>
<b>TRL</b>	<b>-</b>
(1)	(2)
(3)	(4)
(5)	(6)
(7)	(8)
<b>1</b>	- Current Rating (7A)
<b>2</b>	- C = Center Tap Configuration
<b>3</b>	- Package Identifier W = D-Pak
<b>4</b>	- Schottky "Q" Series
<b>5</b>	- Voltage Rating (10 = 100V)
<b>6</b>	- FN = TO-252AA
<b>7</b>	- <ul style="list-style-type: none"> <li>• none = Tube (50 pieces)</li> <li>• TR = Tape &amp; Reel</li> <li>• TRL = Tape &amp; Reel (Left Oriented)</li> <li>• TRR = Tape &amp; Reel (Right Oriented)</li> </ul>
<b>8</b>	- <ul style="list-style-type: none"> <li>• none = Standard Production</li> <li>• PbF = Lead-Free</li> </ul>

Data and specifications subject to change without notice.  
 This product has been designed and qualified for AEC Q101 Level.  
 Qualification Standards can be found on IR's Web site.



## Notice

The products described herein were acquired by Vishay Intertechnology, Inc., as part of its acquisition of International Rectifier's Power Control Systems (PCS) business, which closed in April 2007. Specifications of the products displayed herein are pending review by Vishay and are subject to the terms and conditions shown below.

Specifications of the products displayed herein are subject to change without notice. Vishay Intertechnology, Inc., or anyone on its behalf, assumes no responsibility or liability for any errors or inaccuracies.

Information contained herein is intended to provide a product description only. No license, express or implied, by estoppel or otherwise, to any intellectual property rights is granted by this document. Except as provided in Vishay's terms and conditions of sale for such products, Vishay assumes no liability whatsoever, and disclaims any express or implied warranty, relating to sale and/or use of Vishay products including liability or warranties relating to fitness for a particular purpose, merchantability, or infringement of any patent, copyright, or other intellectual property right.

The products shown herein are not designed for use in medical, life-saving, or life-sustaining applications. Customers using or selling these products for use in such applications do so at their own risk and agree to fully indemnify Vishay for any damages resulting from such improper use or sale.

International Rectifier®, IR®, the IR logo, HEXFET®, HEXSense®, HEXDIP®, DOL®, INTERO®, and POWIRTRAIN® are registered trademarks of International Rectifier Corporation in the U.S. and other countries. All other product names noted herein may be trademarks of their respective owners.